

2 6 8 6 7 8

Container Specification

2,6m
8'6"

Introduction

Hapag-Lloyd offer to their customers six basic types in 20', 40' and 45' versions.

With this wide range of standard and special containers we can provide you with the most suitable container for every product.

This booklet provides exemplary technical data on containers operator by Hapag-Lloyd such as

- dimensions
- weights
- design features

All values listed in the tables are given in metric. Ft and lbs values are for easy reference only.

All details listed are nominal figures. Apart from the tolerances given on internal dimensions on page 5 the tare weight can vary $\pm 2\%$.

In addition to the Hapag-Lloyd container fleet, we can employ a wide range of leased and partner carrier line equipment.

This booklet only lists technical data. If you are looking for further advice or your special requirements are not yet satisfied, we are more than happy to assist you.

Please call your nearest Hapag-Lloyd office or agent and let our experience work for you.

For more product or company information, please visit our website, which is frequently updated at: www.hapag-lloyd.com

www.hapag-lloyd.com

General Information

Internal Dimensions

The internal dimensions and door openings of all Hapag-Lloyd containers exceed the below given ISO dimensions. However, the dimensions mentioned on the following pages are nominal figures. Because of production tolerances a difference in measurement is possible:

Tolerances	Length	Width	Height
Maximum Difference	10 mm 3/8"	10 mm 3/8"	10 mm 3/8"

Maximum Gross Weights

20' containers:

32500 kg (71650 lbs) valid for most Hapag-Lloyd 20' containers; exceeds ISO minimum standards (ISO 668).

40' and 45' containers:

Up to 34 000 kg (74 959 lbs).

Weight Limits for road and rail transport

For individually valid limits contact your local Hapag-Lloyd office.

Floor Loads

A container floor is capable of carrying a fork-lift truck with a maximum axle load of 5 460 kg (12 040 lbs), if the contact area per wheel is at least 142 cm² (22 sq.in) (ISO 1496/I).

Concentrated Loads

Concentrated loads are loads, that are not distributed over the full length of floor, when stowing heavy cargo in containers other than flats or platforms due care has to be taken that concentrated loads will not exceed the strength of the bottom construction of the container.

The maximum spreaded load should not exceed

- for 20' containers 4 ts per running meter in length (3'3³/₈"') still higher on request
- for 40' containers 3 ts per running meter in length
- load must not exceed over max. payload

Gooseneck Tunnel on 40' Containers

All Hapag-Lloyd 40' containers are fitted with a Gooseneck tunnel to enable the transport on Gooseneck chassis.

Timber Treatment

Exposed timber is treated according to Australian, EU, Chinese and American requirements.

Container Markings

Containers built in 1997 or thereafter do also show the ISO Size Type Code.

For further information please see page 46.





External and Minimum Internal Dimensions (according ISO)

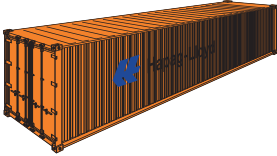
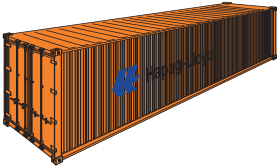

The following table gives the overall dimensions as standardized in ISO 668 and the minimum internal dimensions and door openings for General Purpose Containers as standardized in ISO 1496-1.

Dimensions	Length			Width	Height	
	20'	40'	45'	8'	8'6"	9'6"
Dimensions	6 058 mm	12 192 mm	13 716 mm	2 438 mm	2 591 mm	2 896 mm
Minimum Internal Dimensions	5 867 mm 19'3"	11 998 mm 39'4 ³ / ₈ "	13 532 mm 44'4 ³ / ₄ "	2 330 mm 7'7 ³ / ₄ "	2 350 mm 7'8 ¹ / ₂ "	2 655 mm 8'8 ¹ / ₂ "
Minimum Door Opening Dimensions	–	–	–	2 286 mm 7'6"	2 261 mm 7'5"	2 566 mm 8'5"

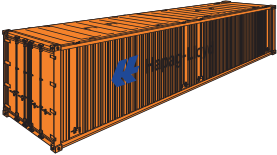
Contents

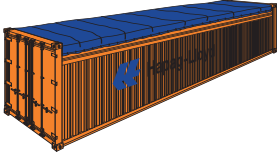
page

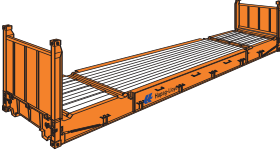
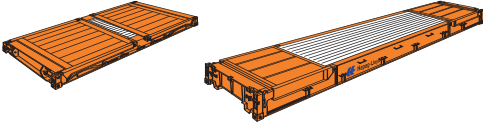
Introduction			3
General Information			5
General Purpose Container		20' 40'	8 10
High Cube General Purpose Container		40'	12
High Cube General Purpose Container		45'	14
Hardtop Container		20' 40'	16 18
High Cube Hardtop Container		40'	20
Open Top Container		20' 40'	24 26

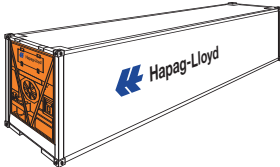
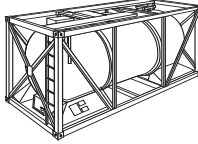
Flat		20'	30
High Cube Flat		40'	32
Platform		20' 40'	34
Ventilated Container		20'	36
Refrigerated Container		20'	38
High Cube Refrigerated Container		40'	40
Tank Container		20'	44
Electric Plugs on Refrigerated Containers			42
Change of Temperature setpoint on Refrigerated Containers			43
Essential Conversion Factors			45
Container Size Type Codes			46

General Purpose Container

20'

ISO Size Type Code: 22G0, 22G1



- Majority of containers tested for ONE DOOR-OFF OPERATION limited stacking weight.
- Suitable for any general cargo.
- Containers may be equipped with liner bags suitable for bulk cargo, e.g. malt.
- Fork-lift pockets for loaded containers.
- Floor Height 170 mm - 5mm (Ground level to interior floor surface)
- Various lashing devices on the top and bottom longitudinal rails and the corner posts.
- Lashing devices have a load of 1 000 kg (2 205 lbs) each.

General Purpose Container

20'

Construction	Inside Dimensions			Door Opening		Weights			Capacity
	Length	Width	Height	Width	Height	Max. Gross	Tare	Max. Payload	
8'6" high	mm ft	mm ft	mm ft	mm ft	mm ft	kg lbs	kg lbs	kg lbs	m ³ cu.ft
Steel container with corrugated walls and wooden floor	5 895 19'4 1/8"	2 350 7'8 1/2"	2 392 7'10 1/8"	2 340 7'8 1/8"	2 292 7'6 1/4"	30 480 67 200	2 250 4 960	28 230 62 240	33,2 1172
	5 900 19'4 1/4"	2 352 7'8 5/8"	2 395 7'10 1/4"	2 340 7'8 1/8"	2 292 7'6 1/4"	32 500 71 650	2 370 5 220	30 130 66 430	33,2 1172
and steel floor	5 895 19'4 1/8"	2 350 7'8 1/2"	2 392 7'10 1/8"	2 340 7'8 1/8"	2 292 7'6 1/4"	32 500 71 650	2 570 5 670	29 930 65 980	33,2 1172

Hapag-Lloyd Serial Number	Foot-note
CPSU 100 000 – 108 362 CPSU 108 470 – 182 099 IVLU 955 076 – 957 000 HLXU 200 000 – 212 799 HLXU 212 800 – 239 799 HLXU 300 000 – 310 099	1) 2) 3) 1) 2) 3)
HLXU 310 100 – 340 699 HLXU 340 800 – 354 699	1) 2) 3) 1) 2) 3)
HLXU 340 700 – 340 799 CPSU 108 363 – 108 469	1) 2) 3) 5)

Construction	Inside Dimensions				Weights			Capacity
	Length	Width	Height		Max. Gross	Tare	Max. Payload	
			Middle	Side				kg lbs
8'6" high ISO Size Type Code: 22U6	mm ft	mm ft	mm ft	mm ft	kg lbs	kg lbs	kg lbs	m ³ cu.ft
Steel container with corrugated walls, wooden floor and removable steel roof	5 886 19'3 3/4"	2 342 7'8 1/8"	2 388 7'10"	2 313 7'7"	30 480 67 200	2 700 5 950	27 780 61 250	32,8 1160
	5 886 19'3 3/4"	2 342 7'8 1/8"	2 388 7'10"	2 313 7'7"	30 480 67 200	2 700 5 950	27 780 61 250	32,8 1160
	5 859 19'3 3/4"	2 350 7'8 1/8"	2 390 7'9 1/2"	2 309 7'7 3/4"	32 500 71 650	2 850 6 280	29 650 65 370	32,1 1132

Hapag-Lloyd Serial Number	Foot-note
FANU 260 200 – 261 799	4)
HLXU 365 000 – 365 649	4)
HLXU 365 650 – 365 949	4)

Remarks:

- 1) 10 lashing rings on each top longitudinal rail; particularly suitable for the transport of hanging garments racks.
- 2) Provided with passive vents.
- 3) Provided with extra lashing rings/bars for the transport of liner bags in the corner posts adjacent to the corner castings.
- 4) For special information please see 20' Hard Top Container.
- 5) Max Gross 30 480 kg

General Purpose Container

40'

ISO Size Type Code: 42G0, 42G1



- Majority of containers tested for ONE DOOR-OFF OPERATION limited stacking weight.
- Suitable for any general cargo.
- Floor Height 170 mm - 5mm (Ground level to interior floor surface)
- 21 lashing rings on each top longitudinal particularly suitable for the transport of hanging garment equipment. Lashing devices have a permissible load of 1000 kg (2 205 lbs) each.

General Purpose Container

40'

Construction	Inside Dimensions			Door Opening		Weights			Capacity
	Length	Width	Height	Width	Height	Max. Gross	Tare	Max. Payload	
8'6" high	mm ft	mm ft	mm ft	mm ft	mm ft	kg lbs	kg lbs	kg lbs	m ³ cu.ft
Steel container with corrugated walls and wooden floor	12 029 39'5½"	2 350 7'8½"	2 392 7'10¼"	2 340 7'8⅛"	2 292 7'6¼"	30 480 67 200	3 780 8 330	26 700 58 870	67,7 2 390
	12 032 39'5⅝"	2 352 7'8⅝"	2 395 7'10¼"	2 340 7'8⅛"	2 292 7'6¼"	32 500 71 650	4 030 8 885	28 470 62 765	67,7 2 390

Hapag-Lloyd Serial Number	Foot-note
CPSU 400 000 – 475 275 HLXU 400 000 – 449 999 HLXU 500 000 – 507 749 HLXU 509 750 – 510 249	
HLXU 507 750 – 509 749 HLXU 510 250 – 542 999	

Construction	Inside Dimensions				Weights			Capacity
	Length	Width	Height		Max. Gross	Tare	Max. Payload	
			Middle	Side				m ³ cu.ft
8'6" high ISO Size Type Code: 42U6	mm ft	mm ft	mm ft	mm ft	kg lbs	kg lbs	kg lbs	m ³ cu.ft
Steel container with corrugated walls, wooden floor and removable steel roof	12 020 39'5¼"	2 342 7'8⅛"	2 388 7'10"	2 313 7'7"	30 480 67 200	4 700 10 360	25 780 56 840	67,2 2 374
	12 020 39'5¼"	2 342 7'8⅛"	2 388 7'10"	2 313 7'7"	30 480 67 200	4 700 10 360	25 780 56 840	67,2 2 374
	12 020 39'5¼"	2 345 7'8¼"	2 380 7'9⅝"	2 300 7'6½"	30 480 67 200	4 700 10 360	25 780 56 840	65,3 2 306

Hapag-Lloyd Serial Number	Foot-note
FANU 462 100 – 462 399	3)
FANU 462 400 – 463 999 HLXU 465 000 – 466 249	3)
HLXU 467 950 – 467 999	3)

Remarks:

3) Special information, please see 40' Hard Top Container.

High Cube General Purpose Container

40'

ISO Size Type Code: 45G0, 45G1



- Especially for voluminous cargo up to max. 2.70 m (8'10¹/₄"') (see table).
- Numerous lashing devices on the top and bottom longitudinal rails and the corner posts.
- Lashing devices have a permissible load of 1000 kg (2205 lbs) each.
- Floor Height 170 mm - 5mm (Ground level to interior floor surface)
- Consider overheight for inland transportation**
- Provided with passive vents. ISO size type code: 45G1

High Cube General Purpose Container

40'

Construction	Inside Dimensions			Door Opening		Weights			Capacity	Hapag-Lloyd Serial Number	Foot-note
	Length	Width	Height	Width	Height	Max. Gross	Tare	Max. Payload			
9'6" high	mm ft	mm ft	mm ft	mm ft	mm ft	kg lbs	kg lbs	kg lbs	m ³ cu.ft		
	12 024 39'5 ³ / ₈ "	2 350 7'8 ¹ / ₂ "	2 697 8'10 ¹ / ₈ "	2 340 7'8 ¹ / ₈ "	2 597 8'6 ¹ / ₄ "	30 480 67 200	4 020 8 860	26 460 58 340	76,3 2 694	HLXU 450 000 – 459 599 HLXU 633 600 – 635 399	
	12 032 39'5 ⁵ / ₈ "	2 350 7'8 ¹ / ₂ "	2 699 8'10 ¹ / ₄ "	2 340 7'8 ¹ / ₈ "	2 597 8'6 ¹ / ₄ "	30 480 67 200	4 000 8 818	26 480 58 378	76,3 2 694	HLXU 600 000 – 627 099 HLXU 631 100 – 631 799 CPSU 600 000 – 648 568	
Steel container with corrugated walls and wooden floor	12 032 39'5 ⁵ / ₈ "	2 352 7'8 ⁵ / ₈ "	2 700 8'10 ¹ / ₄ "	2 340 7'8 ¹ / ₈ "	2 597 8'6 ¹ / ₄ "	32 500 71 650	4 010 8 840	28 490 62 810	76,3 2 694	HLXU 627 100 – 631 099 HLXU 631 800 – 633 599 HLXU 635 400 – 655 899 HLXU 656 000 – 659 899	
and steel floor	12 032 39'5 ⁵ / ₈ "	2 352 7'8 ⁵ / ₈ "	2 700 8'10 ¹ / ₄ "	2 340 7'8 ¹ / ₈ "	2 597 8'6 ¹ / ₄ "	32 500 71 650	4 460 8 840	28 040 62 810	76,3 2 694	HLXU 655 900 – 655 999	

Construction	Inside Dimensions				Weights			Capacity	Hapag-Lloyd Serial Number	Foot-note
	Length	Width	Height		Max. Gross	Tare	Max. Payload			
			mm ft	mm ft				Middle mm ft	Side mm ft	kg lbs
9'6" high ISO Size Type Code: 45U6										
Steel container with corrugated walls, wooden floor and removable steel roof	12 020 39'5 ¹ / ₄ "	2 342 7'8 ¹ / ₈ "	2 693 8'10"	2 618 8'7"	30 480 67 200	4 900 10 803	25 580 56 394	75,8 2 677	HLXU 665 100 – 665 199 HLXU 467 000 – 467 299	1) 1)
	12 020 39'5 ¹ / ₄ "	2 342 7'8 ¹ / ₈ "	2 693 8'10"	2 618 8'7"	32 500 71 650	5 200 11 436	27 300 60 180	76,0 2 684	HLXU 665 200 – 666 849	1)

Remarks:

21 lashing rings on each top longitudinal rail; particularly suitable for the transport of hanging garment equipment.

1) Special information, please see 40' High Cube Hard Top Container.

High Cube General Purpose Container

45'

ISO Size Type Code: L5G0, L5G1



- Especially for voluminous cargo up to max. 2.70 m (8'10¹/₄"') (see table).
- Minimum 10 Lashing rings on the top and bottom longitudinal rails.
- Units built with corner castings at 40 ft and 45 ft positions.
- Lashing devices have a permissible load of 1000 kg (2 205 lbs) each.
- Floor Height 170 mm - 5mm (Ground level to interior floor surface)
- Consider overheight for inland transportation**
- Provided with passive vents**

High Cube General Purpose Container

45'

Construction	Inside Dimensions			Door Opening		Weights			Capacity	Hapag-Lloyd Serial Number	Foot-note
	Length	Width	Height	Width	Height	Max. Gross	Tare	Max. Payload			
9'6" high	mm ft	mm ft	mm ft	mm ft	mm ft	kg lbs	kg lbs	kg lbs	m ³ cu.ft		
Steel container with corrugated walls and wooden floor	13 532 44'4 ³ / ₄ "	2 414 7'11"	2 694 8'10"	2 374 7'9 ¹ / ₂ "	2 585 8'5 ³ / ₄ "	34 000 74 960	4 950 10 910	29 050 64 050	88,4 3 122	UESU 482 601 – 483 100	
	13 557 44'5 ³ / ₄ "	2 353 7'8 ⁵ / ₈ "	2 700 8'10 ¹ / ₄ "	2 340 7'8 ¹ / ₈ "	2 585 8'5 ³ / ₄ "	30 420 67 064	4 820 10 626	25 660 56 570	86,1 3 041	UESU 483 751 – 484 750	
	13 556 44'5 ⁴ / ₆₄ "	2 352 7'8 ¹⁹ / ₃₂ "	2 700 8'10 ¹⁹ / ₆₄ "	2 340 7'8 ¹ / ₈ "	2 597 8'5 ³ / ₄ "	32 500 71 650	5 050 11 130	27 450 60 520	86,1 3 041	HLXU 900 000 – 900 199	1)

Remarks:

1) Lashing rings total 68. Lash roads total 16

Hardtop Container

20'

ISO Size Type Code: 22U6

- This container type has been designed and developed by Hapag-Lloyd.
- It has especially been constructed for
 - heavy loads
 - high, and excessively high loads
 - loading, e.g. by crane, through roof opening and door side.
- Floor Height 170 mm - 5mm (Ground level to interior floor surface)
- With the roof removed and the doorheader swung out, it is much easier to load cargo using a crane via the door side.
- The steel roof of most series (please see footnote) is fitted with fork-lift rings so that it can be removed by using a forklift. The weight of the steel roof is approx. 450 kg (990 lbs).
- In case your cargo has overheight the roof sections can be lashed to a sidewall inside the container using only some 13 cm (5 1/8) of space.
- If required, we can provide disposable tarpaulins for the transport which can be fastened to the walls on the outside using lashing devices.



- The hardtop container provides many lashing devices to fasten your goods. The lashing devices on the corner posts and on the longitudinal rails of the roof and floor are capable of bearing loads of up to 2,000 kg (4,410 lbs) each, and those in the middle of the side walls up to 500 kg (1,100 lbs) each. Lashing to the side walls can only be done after the roof has been closed.
- Fork-lift pockets for loaded containers.
- Utilizable for bulk cargo.
- The roof can easily be lifted by hand 70 mm (2 3/4"), using the roof locking devices so

that the door-header can be swung out without removing the roof.

- This container type has been designed for heavy loads. Whilst considering the technical data (including the permissible spreaded load limitations) please bear in mind the prevalent weight restrictions for land transport.
- For further information please ask for our brochure "The Hardtop Container".

Hardtop Container

20'

Construction	Inside Dimensions				Weights			Capacity	Hapag-Lloyd Serial Number	Foot- note
	Length	Width	Height		Max. Gross kg lbs	Tare kg lbs	Max. Payload kg lbs			
			Middle mm ft	Side mm ft				m ³ cu.ft		
8'6" high Steel container with corrugated walls, wooden floor and removable steel roof	5 886 19'3 ³ / ₄ "	2 342 7'8 ¹ / ₈ "	2 388 7'10"	2 313 7'7"	30 480 67 200	2 700 5 950	27 780 61 250	32,8 1160	FANU 260 200 – 261 399	
	5 887 19'3 ¹³ / ₁₆ "	2 346 7'8 ³ / ₈ "	2 390 7'10 ³ / ₃₂ "	2 315 7'7 ¹ / ₈ "	30 480 67 200	2 590 5 710	27 890 61 490	32,8 1160	HLXU 365 000 – 365 649	1)2)3)
	5 887 19'3 ¹³ / ₁₆ "	2 346 7'8 ³ / ₈ "	2 390 7'10 ³ / ₃₂ "	2 315 7'7 ¹ / ₈ "	32 500 71 650	2 850 6 283	29 650 65 366	31,8 1123	HLXU 365 650 – 365 949	1)2)3)

Remarks:

- 1) Provided with passive vents.
- 2) 10 lashing rings on each top longitudinal rail; particularly suitable for the transport of hanging garment equipment.
- 3) Provided with extra lashing rings/bars for the transport of liner bags in the corner post adjacent to the corner castings.

Roof and door openings please see page 22.

Hardtop Container

40'

ISO Size Type Code: 42U6

- This container type has been designed and developed by Hapag-Lloyd.
- The 40' hardtop container has particularly been constructed for:
 - long loads which cannot be transported in the 20' hardtop container
 - heavy loads
 - high and excessively high loads
 - loading, e.g. by crane, through roof opening and door side.
- With the roof removed and the door header swung out, it is much easier to load cargo using a crane via the door side.
- Provided with lifting devices by forklift truck or crane. The weight of the single steel roof comes within the limits of approx. 450 kg (990 lbs).
- In case your cargo has overheight the roof sections can be lashed to a sidewall inside the container using only some 13 cm (5¹/₈") of space.
- Floor Height 170 mm - 5mm (Ground level to interior floor surface)
- If required, we can provide disposable tarpaulins for the transport which can



- be fastened to the walls on the outside using lashing devices.
- The hardtop container provides many lashing devices to fasten your goods. The lashing devices on the corner posts and on the longitudinal rails of the roof and floor are capable of bearing loads of up to 2,000 kg (4,410 lbs) each, and those in the middle of the side walls up to 500 kg (1,100 lbs) each. Lashing to the side walls can only be done after the roof has been closed.
- The roof can easily be lifted by hand 70 mm (2³/₄"), using the roof locking devices so that the door-header can be swung out without removing the roof.
- This container type has been designed for heavy loads. Whilst considering the technical data (including the permissible spreaded load limitations) please bear in mind the prevalent weight restrictions for land transport.
- For further information please ask for our brochure "The Hardtop Container".

Hardtop Container

40'

Construction	Inside Dimensions				Weights			Capacity	Hapag-Lloyd Serial Number	Foot- note
	Length	Width	Height		Max. Gross kg lbs	Tare kg lbs	Max. Payload kg lbs			
			Middle mm ft	Side mm ft				m ³ cu.ft		
8'6" high	mm ft	mm ft	mm ft	mm ft						
Steel container with corrugated walls, wooden floor and removable steel roof	12 020 39'5¼"	2 342 7'8⅛"	2 388 7'10"	2 313 7'7"	30 480 67 200	4 700 10 360	25 780 56 840	67,2 2374	FANU 462 100 – 462 399	1)
	12 020 39'5¼"	2 342 7'8⅛"	2 388 7'10"	2 313 7'7"	30 480 67 200	4 700 10 360	25 780 56 840	67,2 2374	FANU 462 400 – 463 999 HLXU 465 000 – 466 249	1)
	12 020 39'5¼"	2 345 7'8¼"	2 380 7'9⅝"	2 300 7'6½"	30 480 67 200	4 700 10 360	25 780 56 840	65,3 2306	HLXU 467 950 – 467 999	2)

Remarks:

The 40' hardtop has a removable turnbuckle positioned dead centre between both top rails. This may reduce the cargo height, if left in position and not stored.

- 1) Provided with passive vents.
- 2) Special design, roof locking clips.

Roof and door openings please see page 22.

High Cube Hardtop Container

40'

ISO Size Type Code: 45U6



- This container type has been designed and developed by Hapag-Lloyd.
- The 40' hardtop container has particularly been constructed for:
 - long loads which cannot be transported in the 20' hardtop container
 - heavy loads
 - high and excessively high loads
 - loading, e.g. by crane, through roof opening and door side.
- With the roof removed and the door header swung out, it is much easier to load cargo using a crane via the door side.
- The roof can be removed by using a forklift. The weight of the steel roof is approx. 450 kg (990 lbs) each section.
- In case your cargo has overheight the roof sections can be lashed to a sidewall inside the container using only some 13 cm (5¹/₈") of space.
- Floor Height 170 mm - 5mm (Ground level to interior floor surface)
- If required, we can provide disposable tarpaulins for the transport which can be

fastened to the walls on the outside using lashing devices.

- The hardtop container provides many lashing devices to fasten your goods. The lashing devices on the corner posts and on the longitudinal rails of the roof and floor are capable of bearing loads of up to 2,000 kg (4,410 lbs) each, and those in the middle of the side walls up to 500 kg (1,100 lbs) each. Lashing to the side walls can only be done after the roof has been closed.

- The roof can easily be lifted by hand 70 mm (2³/₄"), using the roof locking devices so that the door-header can be swung out without removing the roof.
- This container type has been designed for heavy loads. Whilst considering the technical data (including the permissible spreaded load limitations) please bear in mind the prevalent weight restrictions for land transport.
- For further information please ask for our brochure "The Hardtop Container".

High Cube Hardtop Container

40'

Construction	Inside Dimensions				Weights			Capacity	Hapag-Lloyd Serial Number	Foot- note
	Length	Width	Height		Max. Gross kg lbs	Tare kg lbs	Max. Payload kg lbs			
			Middle mm ft	Side mm ft				m ³ cu.ft		
9'6" high Steel container with corrugated walls, wooden floor and removable steel roof	12 020 39'5 1/4"	2 342 7'8 1/8"	2 693 8'10"	2 618 8'7"	30 480 67 200	4 900 10 803	25 580 56 394	75,8 2 677	HLXU 467 000 – 467 299	
	12 021 39'5 5/14"	2 346 7'8 3/8"	2 695 8'10 1/8"	2 620 8'7 1/8"	30 480 67 200	4 900 10 803	25 580 56 394	76,0 2 684	HLXU 665 000 – 665 199	
	12 022 39'5 5/16"	2 346 7'8 3/8"	2 695 8'10 1/8"	2 620 8'7 1/8"	32 500 71 650	5 200 11 470	27 300 60 180	76,0 2 684	HLXU 665 200 – 666 949	

Remarks:

Roof with hinged rings for easy removal by a fork-lift truck.

Up to 21 lashing rings on each top longitudinal rail; particularly suitable for the transport of hanging garment equipment.

The 40' hardtop has a removable turnbuckle positioned dead centre between both top rails.

This may reduce the cargo height, if left in position and not stored.

Roof and door openings please see next page.

Provided with passive vents.

Roof and door openings of Hardtop Containers

20', 40', 40'/9'6"

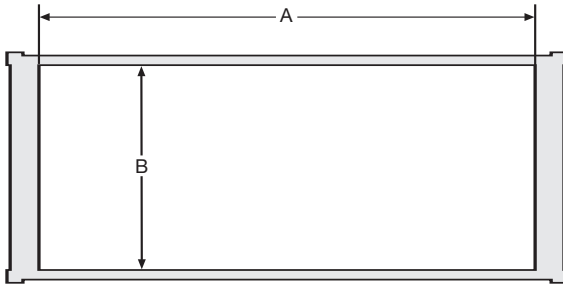

Roof openings

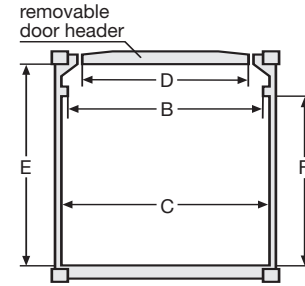

Door openings

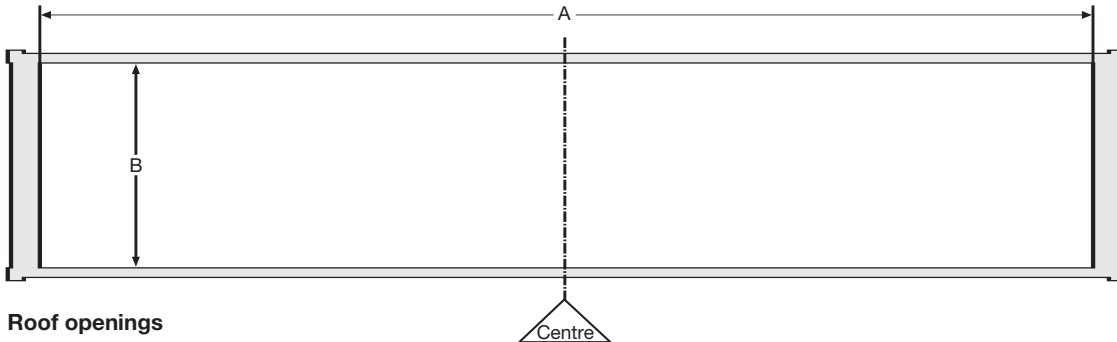

Roof openings

Attention: Reduced inside height due to adjust bar, in the centre ~ -160 mm

Roof and door openings of Hardtop Containers

20', 40', 40'/9'6"

	Roof openings		Door openings			Roof lashed to sidewall					Hapag-Lloyd Serial Number	Foot- note
	Length	Width	Width			Height		Reduced Inside Width				
	A	B	C	D Swing header opening	B Between top rails	E Up to door header	F Up to top rail		Roof opening	Door opening		
mm ft	mm ft	mm ft	mm ft	mm ft	mm ft	mm ft	mm ft	mm ft	mm ft	mm ft		
20' 8'6" high	5 590 18'4"	2 208 7'2 ⁷ / ₈ "	2 336 7'8"	1 896 6'2 ⁵ / ₈ "	2 208 7'2 ⁷ / ₈ "	2 276 7'5 ⁵ / ₈ "	2 220 7'3 ³ / ₈ "	2 209 7'3"	2 142 7'1 ¹ / ₄ "	2 206 7'2 ⁷ / ₈ "	FANU 260 200 – 261 399 HLXU 365 000 – 365 649	
	5 590 18'4"	2 208 7'2 ⁷ / ₈ "	2 336 7'8"	1 896 6'2 ⁵ / ₈ "	2 208 7'2 ⁷ / ₈ "	2 292 7'6 ¹ / ₄ "	2 220 7'3 ³ / ₈ "	2 209 7'3"	2 142 7'1 ¹ / ₄ "	2 206 7'2 ⁷ / ₈ "	FANU 261 400 – 261 799	
	5 590 18'4"	2 208 7'2 ⁷ / ₈ "	2 336 7'8"	1 896 6'2 ⁵ / ₈ "	2 208 7'2 ⁷ / ₈ "	2 275 7'2 ³ / ₄ "	2 231 7'3 ³ / ₄ "	2 215 7'3 ¹ / ₈ "	2 148 7'1 ¹ / ₂ "	2 212 7'3"	HLXU 365 650 – 365 949	
	11 724 38'5 ¹ / ₂ "	2 208 7'2 ⁷ / ₈ "	2 336 7'8"	1 896 6'2 ⁵ / ₈ "	2 208 7'2 ⁷ / ₈ "	2 276 7'5 ⁵ / ₈ "	2 220 7'3 ³ / ₈ "	2 209 7'3"	2 142 7'1 ¹ / ₄ "	2 206 7'2 ⁷ / ₈ "	FANU 462 400 – 463 999 HLXU 465 000 – 465 649	
40' 8'6" high	11 724 38'5 ¹ / ₂ "	2 208 7'2 ⁷ / ₈ "	2 334 7'7 ⁷ / ₈ "	1 882 6'2 ¹ / ₂ "	2 208 7'2 ⁷ / ₈ "	2 290 7'6 ¹ / ₈ "	2 125 6'11 ⁵ / ₈ "	2 205 7'2 ³ / ₄ "	2 102 6'10 ³ / ₄ "	1 996 6'6 ¹ / ₂ "	HLXU 467 950 – 467 999	

	Roof openings		Door openings			Roof lashed to sidewall					Hapag-Lloyd Serial Number	Foot- note
	Length	Width	Width			Height		Reduced Inside Width				
	A	B	C	D Swing header opening	B Between top rails	E Up to door header	F Up to top rail		Roof opening	Door opening		
mm ft	mm ft	mm ft	mm ft	mm ft	mm ft	mm ft	mm ft	mm ft	mm ft	mm ft		
40' 9'6" high	11 724 38'5 ¹ / ₂ "	2 208 7'2 ⁷ / ₈ "	2 336 7'8"	1 896 6'2 ⁵ / ₈ "	2 208 7'2 ⁷ / ₈ "	2 597 8'6 ¹ / ₄ "	2 525 8'3 ³ / ₈ "	2 230 7'3 ³ / ₄ "	2 163 7'1 ¹ / ₈ "	2 227 7'3 ⁵ / ₈ "	HLXU 467 000 – 467 299	
	11 724 38'5 ¹ / ₂ "	2 212 7'2 ¹ / ₈ "	2 340 7'8 ¹ / ₈ "	1 808 5'11 ¹ / ₈ "	2 212 7'3 ¹ / ₈ "	2 581 8'5 ⁵ / ₈ "	2 523 8'3 ³ / ₈ "	2 230 7'3 ³ / ₄ "	2 161 7'1 ¹ / ₈ "	2 227 7'3 ⁵ / ₈ "	HLXU 665 000 – 666 349	

Open Top Container

20'

ISO Size Type Code: 22U1



- Especially for
 - overheight cargo
 - loading from top side, e.g. by crane
 - loading from door side, e.g. with cargo hanging from overhead tackle
- Floor Height 170 mm - 5mm (Ground level to interior floor surface)
- Door header can be swung out on all open top containers

- If required, we can provide disposable tarpaulins. For fastening tarpaulins, lashing bars are available on the outside of the walls. Using one way tarpaulins requires the corner castings to be accessible.
- Fork-lift pockets for loaded containers.
- Numerous lashing devices on the top and bottom longitudinal rails and the corner posts.

Lashing devices have a permissible load of 1 000 kg (2 20 lbs) each.

- **Dimensions of roof and door openings please see page 29.**

Open Top Container

20'

Construction	Inside Dimensions				Weights			Capacity	Hapag-Lloyd Serial Number	Foot- note
	Length	Width	Height		Max. Gross kg lbs	Tare kg lbs	Max. Payload kg lbs			
			Middle mm ft	Side mm ft				m ³ cu.ft		
8'6" high Steel container with corrugated walls, wooden floor and removable tarpaulin	5 888 19'3 ³ / ₄ "	2 345 7'8 ¹ / ₈ "	2 365 7'9"	2 315 7'7 ¹ / ₈ "	30 480 67 200	2 250 4 960	28 230 62 240	32,0 1 130	HLXU 260 000 – 260 849	
	5 897 19'4 ¹ / ₈ "	2 350 7'8 ¹ / ₂ "	2 377 7'9 ¹ / ₂ "	2 347 7'8 ³ / ₈ "	30 480 67 200	2 350 5 180	28 130 62 020	32,5 1 148	CPSU 800 001 – 800 549 HLXU 260 850 – 261 599	
	5 895 19'4 ¹ / ₈ "	2 350 7'8 ¹ / ₂ "	2 380 7'9 ⁵ / ₈ "	2 340 7'8 ³ / ₈ "	32 500 71 650	2 250 4 960	30 250 66 690	32,5 1 148	HLXU 360 000 – 362 999	1)

Remarks :

1) Concentrated load up increased from 4 tons per running meter in length (3'3³/₈"

Open Top Container

40'

ISO Size Type Code: 42U1



- Especially for
 - overheight cargo
 - loading from top side, e.g. by crane
 - loading from door side, e.g. with cargo hanging from overhead tackle
- Floor Height 170 mm - 5mm (Ground level to interior floor surface)

- Door header can be swung out on all open top containers
- Numerous lashing devices on the top and bottom longitudinal rails and the corner posts. Lashing devices have a permissible load of 1 000 kg(2 205 lbs) each.

- **Dimensions of roof and door openings please see page 29.**

Open Top Container

40'

Construction	Inside Dimensions				Weights			Capacity	Hapag-Lloyd Serial Number	Foot- note
	Length	Width	Height		Max. Gross kg lbs	Tare kg lbs	Max. Payload kg lbs			
			Middle mm ft	Side mm ft				m ³ cu.ft		
8'6" high	12 029 39'5 1/2"	2 342 7'8 1/8"	2 376 7'9 1/2"	2 326 7'7 1/2"	30 480 67 200	3 810 8 400	26 670 58 800	65,5 2 310	HLXU 460 000 – 460 799	
	12 022 39'5 1/4"	2 345 7'8 1/8"	2 365 7'9 1/8"	2 315 7'7 1/8"	30 480 67 200	3 740 8 245	26 740 58 955	65,3 2 306	FANU 461 500 – 261 749	
Steel container with corrugated walls, wooden floor and removable tarpaulin	12 030 39'5 5/8"	2 350 7'8 1/2"	2 377 7'9 1/2"	2 347 7'8 3/8"	30 480 67 200	3 850 8 490	26 630 58 710	66,4 2 345	HLXU 460 800 – 462 119	
	12 029 39'5 1/2"	2 350 7'8 1/2"	2 380 7'9 5/8"	2 346 7'8 3/8"	32 500 71 650	4 050 8 929	28 450 62 721	66,5 2 350	HLXU 560 000 – 566 699	

Roof and door openings of Open Top Containers

20', 40'

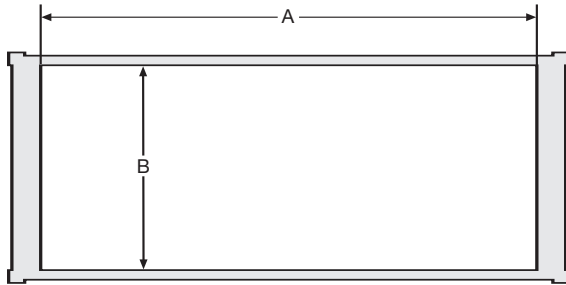

Roof openings

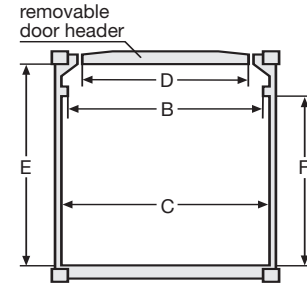

Door openings

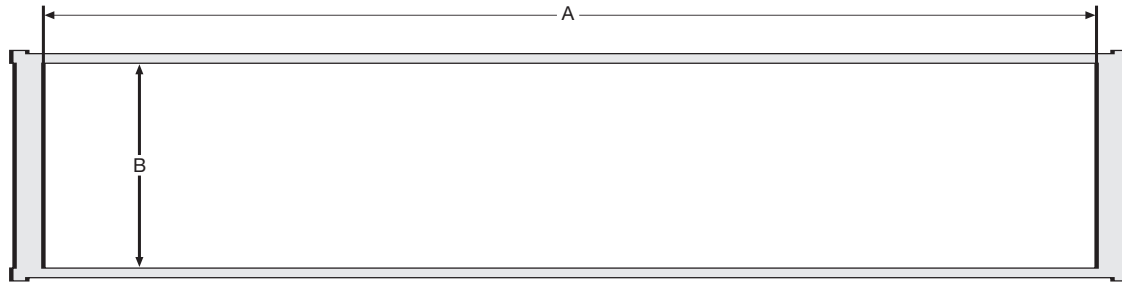

Roof openings

Roof and door openings of Open Top Containers

20', 40'

20' 8'6" high	Roof openings		Door openings					Hapag-Lloyd Serial Number	Foot- note
	Length	Width	Width			Height			
	A	B	C	D Swing header openings	B Between top rails	E Up to door header	F Up to top rail		
	mm ft	mm ft	mm ft	mm ft	mm ft	mm ft	mm ft		
5 360 17'7"	2 205 7'2 ³ / ₄ "	2 335 7'8"	1 880 6'2"	2 205 7'2 ³ / ₄ "	2 280 7'5 ³ / ₄ "	2 125 6'11 ⁵ / ₈ "	HLXU 260 000 – 260 849		
5 338 17'6 ¹ / ₈ "	2 230 7'3 ³ / ₄ "	2 338 7'8"	1 902 6'2 ⁷ / ₈ "	2 230 7'3 ³ / ₄ "	2 280 7'5 ³ / ₄ "	2 231 7'1"	CPSU 800 001 – 800 549 HLXU 260 850 – 261 599		
5 338 17'6 ¹ / ₈ "	2 230 7'3 ³ / ₄ "	2 338 7'8"	1 899 6'2 ⁷ / ₈ "	2 230 7'3 ³ / ₄ "	2 280 7'5 ³ / ₄ "	2 231 7'1"	HLXU 360 000 – 361 549		

40' 8'6" high	Roof openings		Door openings					Hapag-Lloyd Serial Number	Foot- note
	Length	Width	Width			Height			
	A	B	C	D Swing header openings	B Between top rails	E Up to door header	F Up to top rail		
	mm ft	mm ft	mm ft	mm ft	mm ft	mm ft	mm ft		
11 544 37'10 ¹ / ₂ "	2 230 7'3 ³ / ₄ "	2 336 7'8"	1 885 6'2 ¹ / ₈ "	2 230 7'3 ³ / ₄ "	2 280 7'5 ³ / ₄ "	2 146 7'1 ¹ / ₂ "	HLXU 460 000 – 460 799		
11 550 37'10 ³ / ₄ "	2 205 7'2 ³ / ₄ "	2 335 7'8"	1 880 6'2"	2 205 7'2 ³ / ₄ "	2 280 7'5 ³ / ₄ "	2 125 6'11 ⁵ / ₈ "	FANU 461 500 – 461 749		
11 573 37'11 ⁵ / ₈ "	2 210 7'3"	2 338 7'8"	1 902 6'2 ⁷ / ₈ "	2 210 7'3"	2 292 7'6 ¹ / ₄ "	2 131 6'11 ⁷ / ₈ "	HLXU 460 800 – 362 119		
11 552 37'10 ³ / ₄ "	2 230 7'3 ³ / ₄ "	2 340 7'8 ¹ / ₈ "	1 900 6'2 ¹³ / ₁₆ "	2 230 7'3 ³ / ₄ "	2 282 7'5 ³ / ₄ "	2 163 7'1 ¹ / ₈ "	HLXU 560 000 – 566 699		

Flat - All Types

20'

ISO Size Type Code: 8'6" high, 22P3, 22P8

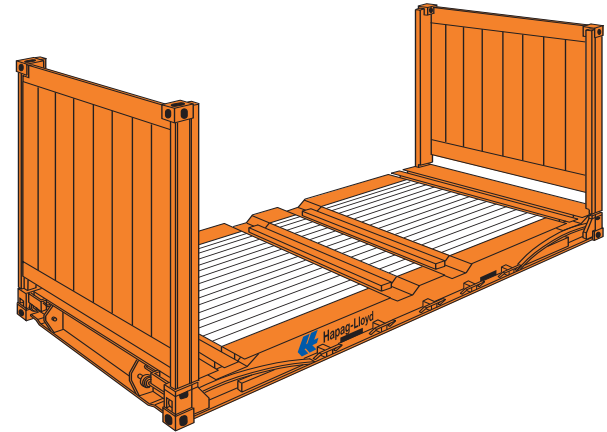

- Especially for heavy loads and over-size cargo as well as project cargo.
- Fork-lift pockets for loaded containers.
- Numerous very strong lashing devices on the corner posts, longitudinal rails and on the floor or base ends. Lashing devices on the longitudinal rails have a permissible load up to 5 000 kg each.
- **Maximum payload can only be used if distributed over the total floor area of flatrack. If concentration of heavy load on a small part of floor area is required please contact your Hapag-Lloyd partner office for stowage advice.**
- Flats are delivered without stanchions. If stanchions are required please inform us upon booking.
- Collapsible flatracks, provided with spring assisted endwalls.
- Collapsible flatracks, provided with twistlocks to interlock 7 units into a 8'6" high pile.

Flat

20'

Construction	Inside Dimensions						Weights			Hapag-Lloyd Serial Number	Foot-note
	Length between panels mm ft	Length between posts mm ft	Width between posts mm ft	Width over bott side rails mm ft	Height floor to top face mm ft	Height of bottom mm ft	Max. Gross kg lbs	Tare kg lbs	Max. Payload kg lbs		
8'6" high											
Flat/Platform with flushfolding endwalls and softwood floor	6038 19'9 ³ / ₄ "	5638 18'6"	2 226 7'3 ⁵ / ₈ "	2 208 7'2 ³ / ₈ "	2 233 7'3 ⁷ / ₈ "	370 1'2 ¹ / ₂ "	40 000 88 184	2 940 6 482	37 060 81 702	HLXU 368 000 – 368 699	1)
	6038 19'9 ³ / ₄ "	5638 18'6"	2 226 7'3 ⁵ / ₈ "	2 194 7'2 ⁷ / ₈ "	2 233 7'3 ⁷ / ₈ "	370 1'2 ¹ / ₂ "	45 000 99 200	2 900 6 400	42 060 92 800	HLXU 368 700 – 369 499	1)2)
Steelframe with collapsible endwalls and softwood floor	5 950 19'6 ¹ / ₄ "	5 644 18'6 ¹ / ₈ "	2 224 7'3 ¹ / ₂ "	2 194 7'2 ⁷ / ₈ "	2 226 7'3 ⁵ / ₈ "	370 1'2 ¹ / ₂ "	33 000 72 752	2 850 6 238	30 150 66 469	HLXU 268 000 – 268 149	3)
Flat/Platform with flushfolding endwalls and softwood floor	6038 19'9 ³ / ₄ "	5638 18'6"	2 226 7'3 ⁵ / ₈ "	2 208 7'2 ³ / ₈ "	2 235 7'4"	370 1'2 ¹ / ₂ "	30 480 67 200	2 520 5 560	27 960 61 64	HLXU 268 500 – 268 599	
	6038 19'9 ³ / ₄ "	5612 18'4 ⁷ / ₈ "	2 225 7'3 ⁵ / ₈ "	2 210 7'3"	2213 7'3 ¹ / ₈ "	370 1'2 ¹ / ₂ "	34 000 74 950	2 740 6 040	31 260 68 910	HLXU 268 600 – 269 399	1)

Remarks:

- 1) Length between hinges at floor level: about 83mm less between posts
- 2) no stanchions pockets
- 3) collapsible but not flushfolding

High Cube Flat

40'

ISO Size Type Code: 45P8

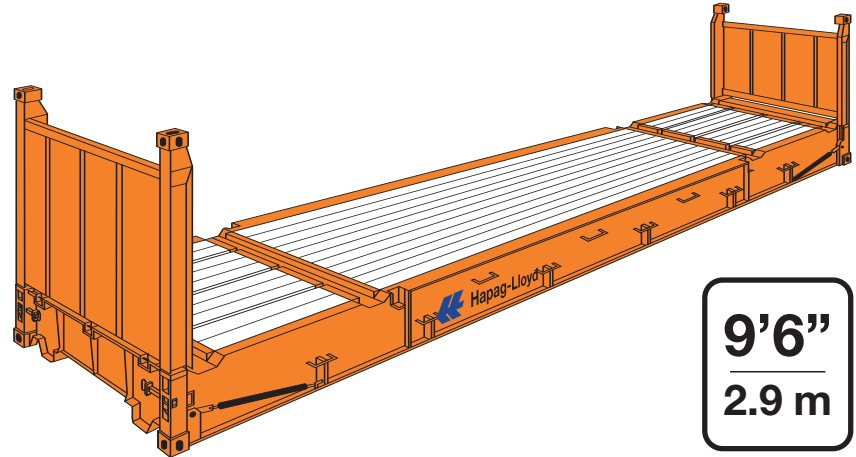

- Especially for heavy loads and oversize cargo as well as project cargo.
- Extraordinary very strong frame design with folding endwalls which allow bracing and lashing as well as stacking.
- Collapsible flatracks, provided with twist-locks to interlock 4 units into a 8'6" high pile.
- Collapsible flatracks, provided with spring assisted endwalls.
- Used as "Tween decks" in cargo holds and on hatch covers for oversized cargoes.
- Numerous very strong lashing devices on longitudinal rails and base ends have a permissible load of 5 000 kg each.
- Gooseneck tunnel on both ends of all 40' flats.
- **The permissible payload of the flat depends on the resting length of the cargo onto the floor.**
- **Maximum payload can only be used if distributed over the total floor area of the flatrack. If heavy loads are shorter, the payload is reduced. Hapag-Lloyd partner office will give stowage advice.**
- Heavy cargo must rest on the main girder.
- Flats are delivered without stanchions.

High Cube Flat

40'

Construction	Inside Dimensions						Weights			Hapag-Lloyd Serial Number	Foot- note
	Length of floor	Length between posts	Width of floor	Width between side rails	Height floor to top face	Height of bottom	Max. Gross	Tare	Max. Payload		
9'6" high	mm ft	mm ft	mm ft	mm ft	mm ft	mm ft	kg lbs	kg lbs	kg lbs		
Steelframe with collapsible flush- folding endwalls – can be converted to a platform	12 060 39'6 ³ / ₄ "	11 660 38'3 ¹ / ₈ "	2 365 7'9 ¹ / ₈ "	2 200 7'2 ⁵ / ₈ "	2 245 7'4 ³ / ₈ "	648 2'1 ¹ / ₂ "	45 000 99 210	5 700 12 570	39 300 86 640	FANU 468 400 – 468 599 HLXU 468 000 – 469 799	
	12 084 39'7 ³ / ₄ "	11 662 38'3 ³ / ₈ "	2 224 7'3 ¹ / ₂ "	2 368 7'9 ¹ / ₄ "	2 245 7'4 ³ / ₈ "	648 2'1 ¹ / ₂ "	50 000 110 230	5 950 13 120	44 050 97 110	HLXU 668 000 – 669 899	1)
no stanchions pockets	12 048 39'6 ¹ / ₄ "	11 652 38'2 ³ / ₄ "	2 320 7'7 ³ / ₈ "	2 347 7'8 ³ / ₈ "	2 265 7'5 ¹ / ₈ "	648 2'1 ¹ / ₂ "	55 000 121 250	5 900 12 900	49 100 108 350	HLXU 868 000 – 869 599	1)

Remarks:

Timber treated according to Australien requirements.

1) Lashing rings 17 each side

Flat-Collapsible and/or Convertible into a Platform

20'/40'

ISO Size Type Code: according to Flat Series

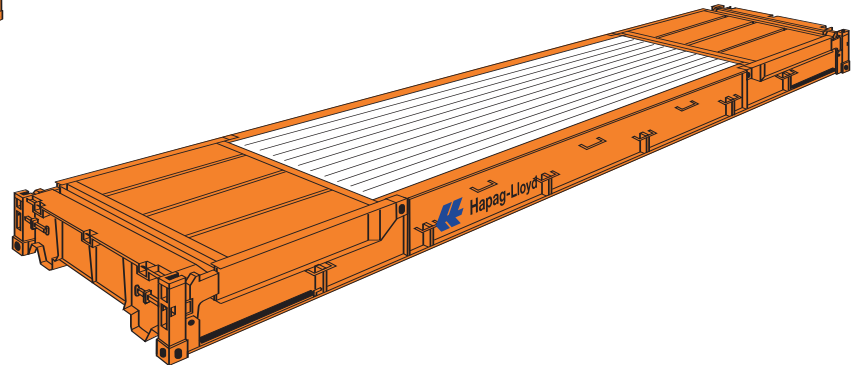
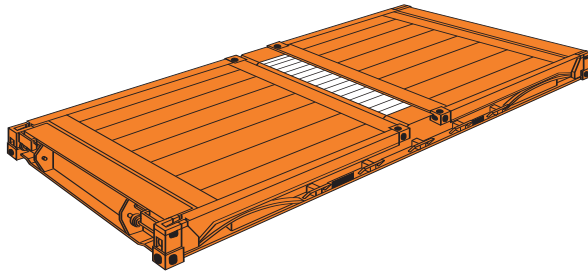

- Especially for heavy loads and oversized cargo.
- Strong bottom construction.
- Gooseneck tunnel on both ends of all 40' platforms.
- Static load up to 85 000 kg as a 40' foundation base. On request available
- Other features please see comparatively flat series.
- Timber treated according to Australian requirements.
- Numerous very strong lashing devices.
- Easy handling/transportation:
20' interlocked pile of max. 7 units
40' interlocked pile of max. 4 units
Combined height of less than 2 591 mm 8'6".
- Transport of heavy loads concentrated on a small load transfer area is possible.
- **Special requirements for big and more heavy cargoes, please contact our special cargo department. Solution plans are already worked out or will be calculated.**

Platform

20'/40'

Construction	Inside Dimensions			Weights			Hapag-Lloyd Serial Number	Foot- note
	Length	Width	Height of bottom	Max. Gross	Tare	Max. Payload		
	mm ft	mm ft	mm ft	kg lbs	kg lbs	kg lbs		
1'11/4" high 20' Steel container with collapsible flushfolding endwalls – can be converted to a platform	6 058 20'	2 438 8'	370 1'2 1/2"	30 480 67 200	2 520 5 560	27 960 61 640	HLXU 268 500 – 268 599	1)
	6 058 20'	2 438 8'	370 1'2 1/2"	34 000 74 950	2 740 6 040	31 260 68 910	HLXU 268 600 – 269 099	1)
	6 058 20'	2 438 8'	370 1'2 1/2"	40 000 88 180	2 940 6 480	37 060 81 700	HLXU 368 000 – 368 699	1)
	6 058 20'	2 438 8'	370 1'2 1/2"	32 500 71 650	4 050 8 929	28 450 62 721	HLXU 368 700 – 369 499	1)
	12 192 40'	2 245 7'4 3/8"	648 2'1 1/2"	45 000 99 210	5 700 12 570	39 300 86 640	FANU 468 400 – 468 599 HLXU 468 000 – 469 799	2)3) 2)3)
2' high 40' Steel container with collapsible flushfolding endwalls – can be converted to a platform	12 192 40'	2 245 7'4 3/8"	648 2'1 1/2"	50 000 110 230	5 950 13 120	44 050 97 110	HLXU 668 000 – 669 999	2)3)
	12 192 40'	2 245 7'4 3/8"	648 2'1 1/2"	55 000 121 250	5 850 12 900	49 150 108 350	HLXU 868 000 – 869 999	2)3)

Remarks:

- 1) Fork-lift pockets
- 2) Useable as a foundation base, static load up to 85.000 kg on request available
- 3) Equipped with 2 gooseneck tunnels

Ventilated Container

20'

ISO Size Type Code: 22V0



- Especially for cargo which needs ventilation.
- Fork-lift pockets for loaded containers.
- Floor Height 170 mm - 5mm (Ground level to interior floor surface)

- Natural ventilation is provided by openings in top and bottom longitudinal rails. The labyrinth construction of these ventilation openings ensures weatherproofness.

- Numerous lashing devices on the top and bottom longitudinal rails and the corner posts. Lashing devices have a permissible load of 1000 kg (2205 lbs) each.

Ventilated Container

20'

Construction	Inside Dimensions			Door Opening		Weights			Capacity	Hapag-Lloyd Serial Number	Foot- note
	Length	Width	Height	Width	Height	Max. Gross	Tare	Max. Payload			
8'6" high	mm ft	mm ft	mm ft	mm ft	mm ft	kg lbs	kg lbs	kg lbs	m ³ cu.ft		
Steel container with corrugated walls and wooden floor	5 880 9'4 ³ / ₄ "	2 325 7'7 ¹ / ₂ "	2 392 7'10 ¹ / ₈ "	2 334 7'7 ⁷ / ₈ "	2 290 7'6 ¹ / ₈ "	30 480 67 200	2 400 5 290	28 080 61 910	33 1167	HLXU 250 000 – 250 599	
	5 895 19'4 ¹ / ₈ "	2 321 7'7 ³ / ₈ "	2 392 7'10 ¹ / ₈ "	2 340 7'8 ¹ / ₈ "	2 292 7'6 ¹ / ₄ "	30 480 67 200	2 290 5 490	27 990 61 710	33 1167	HLXU 250 600 – 251 749	2)3)

Remarks:

10 lashing rings on each top longitudinal rail; particularly suitable for the transport of hanging garments racks.

2) Provided with extra lashing rings/bars for the transport of liner bags in the corner posts adjacent to the corner castings.

3) ISO size type code: 22 V0

Refrigerated Container (Temperature Controlled Container)

20'

ISO Size Type Code: 22R1, 22R9

- Unique inspection and maintenance (PTI) procedure prior shipments
- Container built and tested to fulfill or even exceed industrial standards and regulations.
- Each single container certified by leading classification societies.
- State of the art insulation factors.
- Low CO2 footprint due to low power consuming refrigeration technology.
- Only environment friendly refrigerants used.
- Container available to maintain temperature control range as low as -35°C up to + 30°C
- Containers built to maintain temperature in ambient environment up to 50°C.
- State of the art integrated data logger storing temperatures and events hourly.
- Advanced fresh air exchange control based on CO2 available.
- Transfresh option available.
- Fresh air recording available.
- Controlled fresh air supply with up to 250 cbm/h.
- Most reefers with de-humification option equipped.
- MTS multi temp. setting option available.
- Containers certified for cold treatment control (USDA).
- ATO-DLO certification e.g.for flower bulb transportation.
- Bulb Mode option available.
- On demand defrost avoiding unnecessary heat supply.
- Dedicated equipment for non-foodstuff cargoes, others solely for foodstuff cargoes.
- Low tare weight = high payload designed container.
- Hygienically designed sealing free container with side lining protecting scuff lining.
- Please note maximum stowage height in below tables as indicated red line inside the container in order to ensure proper air circulation
- All cargo shall be pre-cooled to match the required in transit temperature.
- Technical specification and illustration of electric plug see page 42.
- All containers suitable for shore power supply like clip-on generators.
- Voltages: 380V/50 Hz to 460V/60Hz

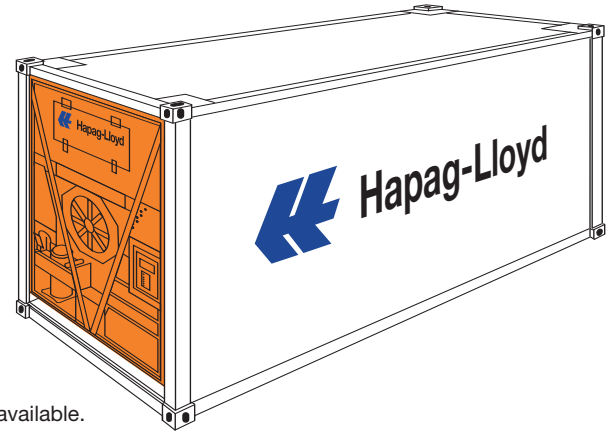

Refrigerated Container

20'

Containers are available for set points as low as **-35° C and up to +30° C**, please contact your local Hapag-Lloyd office for availability.

Construction	Inside Dimensions				Door opening		Weights			Capacity	Hapag-Lloyd Serial Number	Foot-note
	Length	Width	Height	Max. stow. Height	Width	Height	Max. Gross	Tare	Max. Payload			
8'6" high Steelframe, Sandwich walls	mm	mm	mm	mm	mm	mm	kg	kg	kg	m ³		
	ft	ft	ft	ft	ft	ft	lbs	lbs	lbs	cu.ft		
	5 479 17'11 ⁵ / ₈ "	2 286 7'6"	2 257 7'4 ⁷ / ₈ "	2 157 7'7 ⁷ / ₈ "	2 286 7'6"	2 220 7'3 ³ / ₈ "	30 480 67 200	3 160 6 970	27 320 60 230	28,3 999	HLXU 270 000 – 270 499 HLXU 171 000 – 171 249	1)
	5 459 17'10 ⁷ / ₈ "	2 295 7'6 ³ / ₈ "	2 268 7'5 ¹ / ₄ "	2 168 7'1 ³ / ₈ "	2 291 7'6 ¹ / ₈ "	2 259 7'4 ⁷ / ₈ "	30 480 67 200	3 050 6 720	27 430 60 480	28,4 1003	HLXU 270 500 – 270 699	
	5 448 17'10 ¹ / ₂ "	2 290 7'6 ¹ / ₈ "	2 264 7'5 ¹ / ₈ "	2 164 7'1 ¹ / ₈ "	2 286 7'6"	2 260 7'5"	30 480 67 200	3 060 6 750	27 420 60 450	28,3 999	HLXU 370 000 – 370 849	
	5 534 18'1 ⁷ / ₈ "	2 316 7'7 ¹ / ₈ "	2 331 7'7 ³ / ₄ "	2 231 7'3 ³ / ₄ "	2 316 7'7 ¹ / ₈ "	2 290 7'6 ¹ / ₈ "	30 480 67 200	3 030 6 680	27 450 60 520	29,9 1056	HLXU 370 850 – 371 049	
	5 529 18'1 ⁵ / ₈ "	2 316 7'7 ¹ / ₈ "	2 331 7'7 ³ / ₄ "	2 290 7'6 ¹ / ₈ "	2 316 7'7 ¹ / ₈ "	2 290 7'6 ¹ / ₈ "	30 480 67 200	2 960 6 530	27 520 60 670	29,9 1056	HLXU 371 050 – 371 249	
	5 535 18'1 ⁷ / ₈ "	2 284 7'5 ⁷ / ₈ "	2 270 7'5 ³ / ₈ "	2 224 7'3 ¹ / ₂ "	2 290 7'6 ¹ / ₈ "	2 264 7'5 ¹ / ₈ "	30 480 67 200	2 942 6 490	27 538 60 710	28,7 1014	HLXU 371 250 – 374 999	

Remarks:

1) **Not to be used for foodstuffs.**

Refrigerated Container (Temperature Controlled Container)

40'

ISO Size Type Code: 45R1 High Cube, 42R9

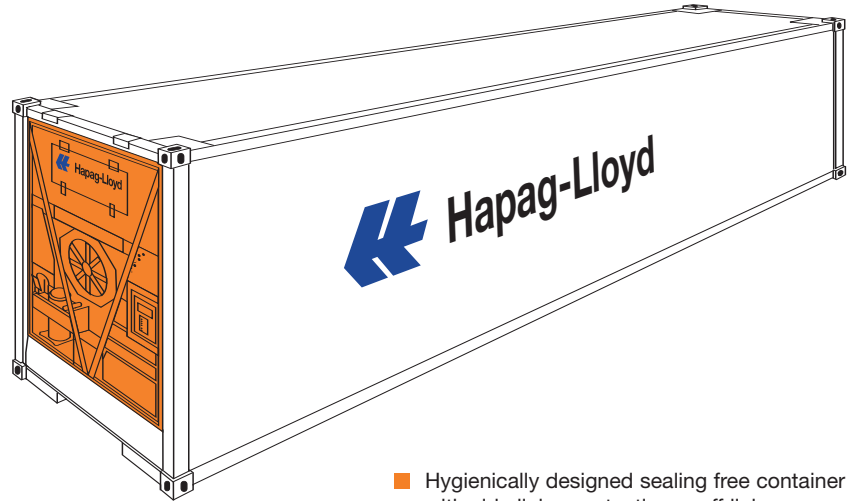

- Unique inspection and maintenance (PTI) procedure prior shipments
- Container built and tested to fulfill or even exceed industrial standards and regulations.
- Each single containers certified by leading classification societies.
- State of the art insulation factors.
- Low CO2 footprint due to low power consuming refrigeration technology.
- Only environment friendly refrigerants used.
- Container available to maintain temperature control range as low as -35°C up to + 30°C
- Containers built to maintain temperature in ambient environment up to 50°C.
- State of the art integrated data logger storing temperatures and events hourly.
- Advanced fresh air exchange control based on CO2 available.
- Transfresh option available.
- Fresh air recording available.
- Controlled fresh air supply with up to 280 cbm/h.
- Mosts reefers with de-humification option equiped.
- MTS multi temp. setting option available.
- Containers certified for cold treatment control (USDA).
- ATO-DLO certification e.g.for flower bulb transportation.
- Bulb Mode option available.
- On demand defrost avoiding unnessary heat supply.
- Dedicated equipment for non-foodstuff cargoes,others solely for foodstuff cargoes.
- Low tare weight = high payload designed container.
- Hygienically designed sealing free container with side lining protecting scuff lining.
- Please note maximum stowage height in below tables as indicated red line inside the container in order to ensure proper air circulation
- All cargo shall be pre-cooled to match the required in transit temperature.
- Technical specification and illustration of electric plug see page 42.
- All containers suitable for shore power supply like clip-on generators.
- Voltages: 380V / 50 Hz to 460V / 60Hz

High Cube Refrigerated Container

40'

Containers are available for set points as low as **-35° C and up to +30° C**, please contact your local Hapag-Lloyd office for availability.

Construction	Inside Dimensions				Door opening		Weights			Capacity	Hapag-Lloyd Serial Number	Foot-note
	Length	Width	Height	Max. stow. Height	Width	Height	Max. Gross	Tare	Max. Payload			
8'6" high non foodstuff	mm ft	mm ft	mm ft	mm ft	mm ft	mm ft	kg lbs	kg lbs	kg lbs	m ³ cu.ft		
Steelframe, Sandwich walls	11 563 37'11¼"	2 294 7'6¼"	2 261 7'5"	2 161 7'1"	2 288 7'6"	2 188 7'2⅛"	34 000 74 960	4 600 10 140	29 400 64 820	60,0 2120	HLXU 770 000 – 770 149	1)
9'6" high	11 577 37'11¼"	2 286 7'6"	2 525 8'3⅜"	2 400 7'10½"	2 286 7'6"	2 490 8'2"	34 000 74 950	4 110 9 060	28 890 65 900	66,8 2 366	HLXU 476 650 – 477 999 HLXU 776 000 – 776 099	1)
	11 555 37'10⅞"	2 294 7'6¼"	2 237 7'4"	2 130 6'11⅞"	2 294 7'6¼"	2 478 8'1½"	34 000 74 950	4 060 9 480	29 940 62 170	66,5 2 400	CPSU 500 000 – 500 327	
	11 590 38'1¼"	2 294 7'6¼"	2 554 8'4½"	2 450 8'⅜"	2 290 7'6⅛"	2 569 8'5⅛"	34 000 74 950	4 660 9 350	29 340 62 250	67,0 2 345	CPSU 510 000 – 517 298	
	11 583 38'	2 286 7'6"	2 532 8'3⅝"	2 412 7'11"	2 294 7'6¼"	2 550 8'4⅜"	34 000 74 950	4 120 9 080	29 880 65 870	67,0 2 366	HLXU 478 600 – 478 999	
	11 595 38'½"	2 296 7'6⅜"	2 542 8'4"	2 402 7'10½"	2 294 7'6¼"	2 550 8'4⅜"	34 000 74 950	4 190 9 230	29 810 65 720	67,7 2 390	HLXU 670 000 – 670 399	
	11 595 38'½"	2 296 7'6⅜"	2 542 8'4"	2 402 7'10½"	2 294 7'6¼"	2 550 8'4⅜"	34 000 74 950	4 150 9 150	29 850 65 609	66,8 2 359	HLXU 670 400 – 677 399	
	Steelframe, Sandwich walls	11 595 38'½"	2 296 7'6⅜"	2 542 8'4"	2 402 7'10½"	2 294 7'6¼"	2 550 8'4⅜"	34 000 74 950	4 150 9 150	29 850 65 609	66,8 2 366	HLXU 870 000 – 879 999

Remarks:

1) **Not to be used for foodstuffs.**

Electric Plug on Refrigerated Containers

- Depending on power sources refrigerated containers are equipped with 1 plug
380 V/50 Hz to 460 V/60 Hz (32 A).
- There are fixed cables with a length of 18 m (49 ft).
- Couplings for adapters are available.
- **Adapters are subject to corresponding safety regulations.**

380/460 V plugs:

- 4poles according to CEE.
- According to ISO 1496-2 annex M.
- **Earth contact in 3hr position according to socket.**

Earth Contact

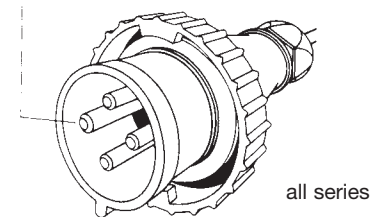

Change of Temperature setpoint on Refrigerated Containers



Thermo King

To change the controller setpoint, turn the **UNIT ON/OFF** switch **ON**.

Complete the following steps:

1. Press the key.
2. Press the or key to scroll to **TEMP SETP** line.
3. Press the key. For a minus setpoint, press the key first. Type the new Temperature setpoint in using the general purpose keypad.
4. Press and hold the key until the cursor stops flashing. The new setpoint appears in the LCD display.
5. Press the key to exit the menu.

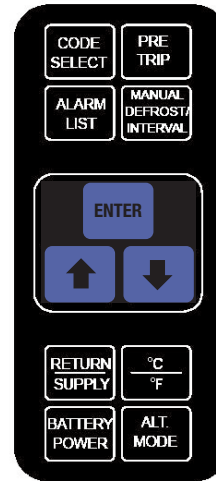

Carrier

1. Press the or key to change the setpoint (the left display will blink).
2. Press the key at the desired setting to confirm and exit the selection menu.

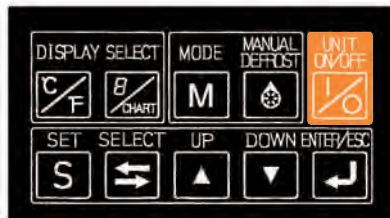

Daikin

1. Press the key to scroll to **"SET-SPC"**.
2. Press the or to change the setpoint.
3. Press the key to set desired setting and exit the menu.

Tank Container

20'

ISO Size Type Codes: 20T5 = 8' high, 22T0 = 8'6" high, 22T5, 22T6

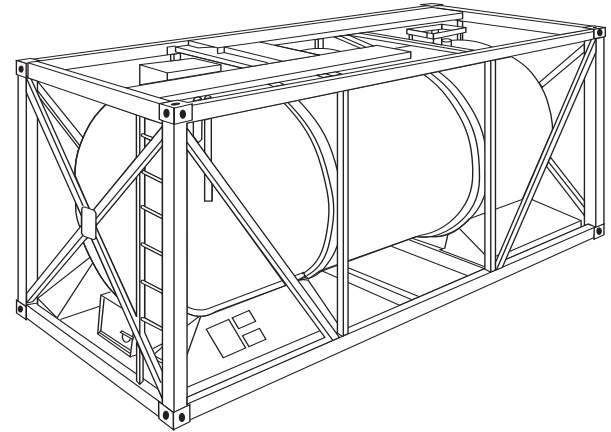

■ Hapag-Lloyd provides tank containers which are approved to the highest standards. Depending on the characteristics of the products to be carried the requirements vary. Hapag-Lloyd offer their services on operational, technical and regulatory questions.

■ Separate tank fleets are available for:

FOODSTUFFS, e.g.:

- Alcohols
- Fruit juices
- Edible oils
- Food additives

CHEMICAL PRODUCTS, e.g.:

- Flammables
- Oxidising agents
- Toxic substances
- Corrosives

■ Tanks must be filled to not less than 80 % of their capacity to avoid dangerous surge/swell during transport.

■ Tanks must not be filled to 100 % of their capacity. Sufficient ullage space shall be left – which must be determined depending on the thermal expansion of the product to be carried.

■ Certain dangerous products must be carried in tanks having no openings below the surface level of the liquid. Such tanks must be discharged through a siphon pipe by either pressure or pumping.

■ National road/rail weight limitations have to be maintained when arranging land transports.

■ For the cleaning of tanks and disposal of residues tariff rules apply. Tanks moving in a dedicated service are exempted from such rules until the dedication is terminated.

■ **For more details please contact your nearest Hapag-Lloyd office or agent and let our experience work for you.**

Essential Conversion Factors

Multiply Number of	by	to obtain equivalent Number of
Inches/in	25.4	Millimetres/mm
Feet/ft	0.3048	Metres/m
Millimetres/mm	0.0394	Inches/in
Metres/m	3.281	Feet/ft
Sq. Metres/m	10.7639	Sq. Feet/ft
Sq. Feet/ft	0.0929	Sq. Metres/m
Cu. Feet/ft	0.0283	Cu. Metres/m
Cu. Metres/m	35.315	Cu. Feet/ft
Litres	0.0353	Cu. Feet/ft
Cu. Feet/ft	28.317	Litres
Litres	0.2642	U.S. Gallons
U.S. Gallons	3.785	Litres
Litres	0.22	U.K. Gallons
U.K. Gallons	4.5461	Litres
U.K. Gallons	1.2001	U.S. Gallons
U.S. Gallons	0.8327	U.K. Gallons
Kilograms/kg	2.2046	Pounds/lb
Pounds/lb	0.4536	Kilograms/kg
Long Tons (2240 lb)	1.01605	Tonnes (2204.62 lb)
Tonnes (1000 Kg)	0.9842	Long Tons (1016.05 Kg)
Bar	14.504	PSI
PSI	0.06895	Bar
Inches HG	0.4912	PSI
PSI	2.036	Inches HG
Kg/sq. cm	14.223	PSI
PSI	0.0703	Kg/sq. cm
Kg/sq. cm	0.9807	Bar
Bar	1.02	Kg/sq. cm
Kg/sq. cm	28.976	Inches HG
Inches HG	0.0345	Kg/sq. cm
Degrees Fahrenheit	5/9, after subtracting 32	Degrees Celsius (Centigrade)
Degrees Celsius (Centigrade)	9/5, and add 32	Degrees Fahrenheit

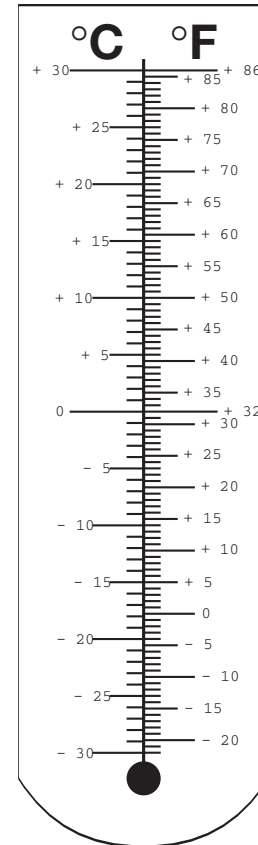

Container Size Type Codes according to ISO 6346

Hapag-Lloyd owned and longterm leased container types

Size (L x H)	Type	ISO	ISO	ISO	ISO
		Type Group	Size Type	Type Group di*	Size Type di*
		1	2	1a	2a
20' x 8"	General Purpose	20GP	20G0		
20' x 8'6"	General Purpose	22GP	22G0		
		22GP	22G1		
20' x 8'6"	General Purpose (Fantainer)	22VH	22V2		
		22VH	22V3*		22V2
20' x 8'6"	Ventilated	22VH	22V0		
20' x 8'6"	Bulk	22BU	22B0		
20' x 8'6"	Open Top	22UT	22U1		
20' x 8'6"	Hardtop	22UP*	22U6*	22UT	22U1
20' x 1'1'1/4"	Platform	29PL	29P0		
20' x 8'	Flat (fixed ends)	20PF	21P1		
20' x 8'6"	Flat (fixed ends)	22PF	22P1		
20' x 8'6"	Flat (collapsible)	22PC	22P3		
20' x 8'6"	Flat (coll., flush folding)	22PC	22P8*		22P3
20' x 8'6"	Refrigerated	22RT	22R1		
20' x 8'6"	Refrigerated (no foodstuffs)	22RC*	22R9*	22RT	22R1
20' x 8'	Insulated	20HR	20H0		
20' x 8'6"	Tank (non-dangerous liquids)	22TN	22T0		
40' x 8'6"	General Purpose	42GP	42G0		
		42GP	42G1		
40' x 9'6"	High Cube GP	45GP	45G0		
		45GP	45G1		
40' x 8'6"	Open Top	42UT	42U1		
40' x 8'6"	Hardtop	42UP*	42U6*	42UT	42U1
40' x 9'6"	High Cube Hardtop	45UP*	45U6*	45UT	45U1
40' x 2'	Platform	49PL	49P0		
40' x 8'6"	Flat (fixed ends)	42PF	42P1		
40' x 8'6"	Flat (collapsible)	42PC	42P3		
40' x 8'6"	Flat (coll., flush folding)	42PC	42P8*		42P3
40' x 9'6"	Flat (collapsible)	45PC	45P3		
40' x 9'6"	Flat (coll., flush folding)	45PC	45P8*		45P3
40' x 8'6"	Refrigerated	42RT	42R1		
40' x 8'6"	Refrigerated (diesel genset)	42RS	42R3		
40' x 8'6"	Refrigerated (no foodstuffs)	42RC*	42R9*	42RS	42R3
40' x 9'6"	Refrigerated	45RT	45R1		
40' x 9'6"	Refrigerated (no foodstuffs)	45RC*	45R9*	45RT	45R1
40' x 8'6"	Insulated	42HR	42H0		
45' x 9'6"	High Cube Cont.	L5GP	L5G1		

*) Some Types/Groups in columns "1" and "2" are marked as non-ISO.

"*." means ISO spares codes have been used.

If official ISO codes are required for data interchange (di) pls use entries in columns "1a" and "2a".

Disclaimer:

While we assume that the information and content provided by us is true and correct, it may, nevertheless, contain errors or inaccuracies.

Hapag-Lloyd does not assume any liability for the accuracy of the information and contents provided in the brochure, or for the consequences resulting from using the information and content provided in the brochure. Hapag-Lloyd does not guarantee or represent that said information and content is exhaustive. Claims as to the exhaustive nature of said information and content are excluded. The information and content is only provided for advertising purposes and is non-binding. No explicit or implied warranties or guarantees are made.

HLXU 5

www.hapag-loyd.com



81

Company headquarters

Hapag-Lloyd AG

Ballindamm 25 · 20095 Hamburg
Germany

Regional head offices

Europe:

Hapag-Lloyd AG

Ballindamm 25 · 20095 Hamburg
Germany

America:

Hapag-Lloyd (America) Inc.

399 Hoes Lane · Piscataway, NJ 08854
USA

Asia:

Hapag-Lloyd (Asia) Pte. Ltd.

200 Cantonment Road #08-03 Southpoint
Singapore 089763